

TAPPI E ACCESSORI PER RADIATORI

Catalogo

Catalogue - Katalog - Catalogue - Catálogo

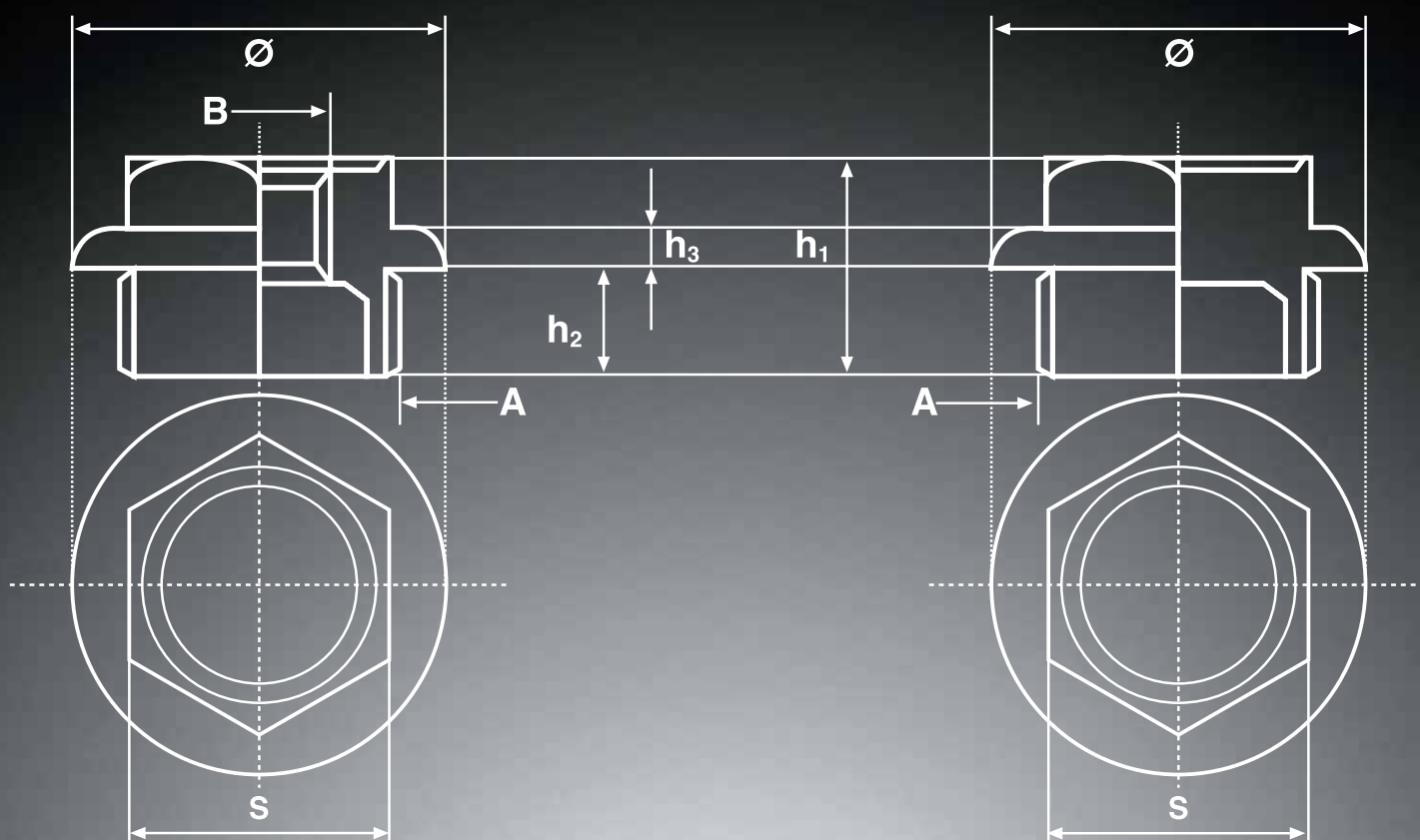

Listino NOVEMBRE 2007 €

Indice Generale • Index • Inhaltsverzeichnis • Index • Indice

TAPPI E RIDUZIONI ACCIAIO PER RADIATORI - RADIATORS STEEL PLUGS AND PLUGS REDUCING - BLIND STAHLSTOPFEN UND ANSCHLUSS STAHLSTOPFEN FÜR RADIATOREN - BOUCHONS ET REDUCTIONS EN ACIER POUR RADIATEURS TAPONES Y TAPONES REDUCIDOS DE ACERO PARA RADIADORES	pag.03
ACCESSORI PER RADIATORI - RADIATOR FITTINGS - RADIATOREN-ZUBERHORTEILE - ACCESSOIRES POUR RADIATEURS ACCESORIOS PARA RADIADORES	pag.07
APPARECCHIATURE PER IMPIANTI IDROTERMICI - EQUIPMENT FOR HYDRO-THERMAL PLANTS - ZUBERHÖR FÜR HEIZUNGEN APPAREILLAGES POUR INSTALLATIONS HYDROTHERMIQUES - APARATOS PARA INSTALACIONES HIDROTERMICAS	pag.09

Tappi zincati

Tappi zincati serie 1/2" con flangia Ø 28 - Range 1/2", galv. with flange Ø 28
1/2", Verzinkt mit Flansch Ø 28 - Serie 1/2", galvanise bride Ø 28
Serie 1/2", zincados con brida Ø 28

201/28	D	Confezione Package	Codice Code	Prezzo € Price
	1/2"	500 dx	201102001	0,508
	1/2" x 1/8"	500 dx	201102181	0,607
	1/2" x 1/4"	500 dx	201102141	0,607
	1/2" x 3/8"	500 dx	201102381	0,607

Tappi zincati serie 3/4" con flangia Ø 34 - Range 3/4", galv. with flange Ø 34
3/4", Verzinkt mit Flansch Ø 34 - Serie 3/4", galvanise bride Ø 34
Serie 3/4", zincados con brida Ø 34

201/34	D	Confezione Package	Codice Code	Prezzo € Price
	3/4"	200 dx	201304001	0,630
	3/4" x 1/8"	200 dx	201304181	0,693
	3/4" x 1/4"	200 dx	201304141	0,693
	3/4" x 3/8"	200 dx	201304381	0,693
	3/4" x 1/2"	200 dx	201304121	0,693

Tappi zincati serie 1" con flangia Ø 42 - Range 1", galv. with flange Ø 42
1", Verzinkt mit Flansch Ø 42 - Serie 1", galvanise bride Ø 42
Serie 1", zincados con brida Ø 42

211/42	D	Confezione Package	Codice Code	Prezzo € Price
 Per Radiatori Alluminio	1"	100 dx	211100001	0,674
	1"	100 sx	211100002	0,674
	1" x 1/8"	100 dx	211100181	0,758
	1" x 1/8"	100 sx	211100182	0,758
	1" x 1/4"	100 dx	211100141	0,758
	1" x 1/4"	100 sx	211100142	0,758
	1" x 3/8"	100 dx	211100381	0,758
	1" x 3/8"	100 sx	211100382	0,758
	1" x 1/2"	100 dx	211100121	0,758
	1" x 1/2"	100 sx	211100122	0,758
	1" x 3/4"	100 dx	211100341	1,247
	1" x 3/4"	100 sx	211100342	1,247

Tappi zincati serie 1" con flangia Ø 48 - Range 1", galv. with flange Ø 48
1", Verzinkt mit Flansch Ø 48 - Serie 1", galvanise bride Ø 48
Serie 1", zincados con brida Ø 48

201/48	D	Confezione Package	Codice Code	Prezzo € Price
 Per Radiatori Ghisa	1"	100 dx	201100001	0,679
	1"	100 sx	201100002	0,679
	1" x 1/8"	100 dx	201100181	0,770
	1" x 1/8"	100 sx	201100182	0,770
	1" x 1/4"	100 dx	201100141	0,770
	1" x 1/4"	100 sx	201100142	0,770
	1" x 3/8"	100 dx	201100381	0,770
	1" x 3/8"	100 sx	201100382	0,770
	1" x 1/2"	100 dx	201100121	0,770
	1" x 1/2"	100 sx	201100122	0,770
	1" x 3/4"	100 dx	201100341	1,264
	1" x 3/4"	100 sx	201100342	1,264

Tappi zincati serie 1 1/4" con flangia Ø 56 - Range 1 1/4", galv. with flange Ø 56
1 1/4", Verzinkt mit Flansch Ø 56 - Serie 1 1/4", galvanise bride Ø 56
Serie 1 1/4", zincados con brida Ø 56

401/56	D	Confezione Package	Codice Code	Prezzo € Price
	1 1/4"	50 dx	401114001	1,298
	1 1/4"	50 sx	401114002	1,298
	1 1/4" x 1/4"	50 dx	401114141	1,405
	1 1/4" x 1/4"	50 sx	401114142	1,405
	1 1/4" x 3/8"	50 dx	401114381	1,405
	1 1/4" x 3/8"	50 sx	401114382	1,405
	1 1/4" x 1/2"	50 dx	401114121	1,405
	1 1/4" x 1/2"	50 sx	401114122	1,405
	1 1/4" x 3/4"	50 dx	401114341	1,596
	1 1/4" x 3/4"	50 sx	401114342	1,596
	1 1/4" x 1"	50 dx	401114101	3,154
	1 1/4" x 1"	50 sx	401114102	3,154

Kit tappi per radiatori

Kit universale per radiatori alluminio 1" flangia Ø 42
Universal kit - Universal-kit - Kit universel - Kit universal

105/42/P	D	Confezione Package	Codice Code	Prezzo € Price
	1" x 3/8"	30	10510038P	6,232
	1" x 1/2"	30	10510012P	6,232

Elementi componenti il kit:
- n.2 riduzioni DX RAL 9010 SEDE PIANA;
- n.2 riduzioni SX RAL 9010 SEDE PIANA;
- n.4 guarnizioni SENZA AMIANTO ø 42 mm2
- n.1 valvola scarico aria art. 975/G 3/8" o art. 979 1/2";
- n.1 tappo ottone con cappuccio bianco
- n.1 chiave in nylon per art. 979 da 1/2".

Kit universale per radiatori tubolari acciaio 1"1/4 flangia ø 56
Universal kit - Universal-kit - Kit universel - Kit universal

105/56	D	Confezione Package	Codice Code	Prezzo € Price
	1"1/4 x 3/8"	20	105114308	11,897
	1"1/4 x 1/2"	20	105114102	11,897

Elementi componenti il kit:
- n.2 riduzioni DX RAL 9010 con guarnizione Silicone montata;
- n.2 riduzioni SX RAL 9010 con guarnizione Silicone montata;
- n.1 valvola scarico aria art. 975/G 3/8" o art. 979 1/2";
- n.1 tappo ottone con cappuccio bianco
- n.1 chiave in nylon per art. 979 da 1/2".

Kit universale per radiatori alluminio 1" flangia Ø 42
Universal kit - Universal-kit - Kit universel - Kit universal

105/42	D	Confezione Package	Codice Code	Prezzo € Price
	1" x 3/8"	30	105100308	6,232
	1" x 1/2"	30	<u>105100102V</u>	6,232

Elementi componenti il kit:
- n.2 riduzioni DX RAL 9010 con guarnizione Silicone montata;
- n.2 riduzioni SX RAL 9010 con guarnizione Silicone montata;
- n.1 **valvola scarico aria art. 975/G**;
- n.1 tappo ottone con cappuccio bianco

NEW

Kit per radiatori Tubor 1"1/4 flangia ø 56
Tubor kit - Tubor-kit - Kit Tubor - Kit Tubor

105/56	D	Confezione Package	Codice Code	Prezzo € Price
	1"1/4 flangia 56	20	<u>105114TUB</u>	11,897

Elementi componenti il kit:
- n.2 riduzioni 1" 1/4" x 1/2" DX RAL 9010 con guarnizione Silicone montata;
- n.1 riduzione 1" 1/4" x 3/8" DX RAL 9010 con guarnizione Silicone montata;
- n.1 tappo cieco da 1" 1/4" DX RAL 9010 con guarnizione Silicone montata;
- n.1 valvola scarico aria art. 975/G 3/8".

NEW

Kit universale per radiatori alluminio 1" flangia Ø 42
Universal kit - Universal-kit - Kit universel - Kit universal

105/42	D	Confezione Package	Codice Code	Prezzo € Price
	1" x 1/2"	30	105100102	6,232

Elementi componenti il kit:
- n.2 riduzioni DX RAL 9010 con guarnizione Silicone montata;
- n.2 riduzioni SX RAL 9010 con guarnizione Silicone montata;
- n.1 **valvola scarico aria art. 979 1/2"**;
- n.1 tappo ottone con cappuccio bianco
- n.1 chiave in nylon per art. 979 da 1/2".

Kit universale per radiatori alluminio 1" flangia ø 42 + mensole
Universal kit - Universal-kit - Kit universel - Kit universal

106/42	D	Confezione Package	Codice Code	Prezzo € Price
	1" x 3/8"	20	10610038MS	9,322
	1" x 1/2"	20	10610012MS	9,322

Elementi componenti il kit:
- n.2 riduzioni DX RAL 9010 con guarnizione Silicone montata;
- n.2 riduzioni SX RAL 9010 con guarnizione Silicone montata;
- n.1 valvola scarico aria art. 975/G 3/8" o art. 979 1/2";
- n.1 tappo ottone con cappuccio bianco
- n.1 coppia mensole MA VERNICIATE SCHIACCIATE 8.8X170
- n.1 chiave in nylon per art. 979 da 1/2".

Kit universale per radiatori ghisa 1" flangia ø 48
Universal kit - Universal-kit - Kit universel - Kit universal

105/48	D	Confezione Package	Codice Code	Prezzo € Price
	1" x 3/8"	20	105101308	6,571
	1" x 1/2"	20	105101102	6,571

Elementi componenti il kit:
- n.2 riduzioni DX RAL 9010;
- n.2 riduzioni SX RAL 9010;
- n.4 guarnizioni SENZA AMIANTO ø 48 mm2
- n.1 valvola scarico aria art. 975/G 3/8" o art. 979 1/2";
- n.1 tappo ottone con cappuccio bianco
- n.1 chiave in nylon per art. 979 da 1/2".

Kit universale att. 1/2" - Universal Kit - Universal-kit - Kit universel - Kit universal

105/28	D	Confezione Package	Codice Code	Prezzo € Price
	1/2"	50	105102000	2,243

Elementi componenti il kit:
- n.1 valvola scarico aria art. 979 1/2";
- n.1 tappo ottone con cappuccio bianco 1/2"

Tappi verniciati su base zincata

Serie 1" verniciati con flangia Ø 42 - Range 1", dressed with flange Ø 42
1", Lackierte mit Flansch Ø 42 - Serie 1", Vernis bride Ø 42
Serie 1", pintados con brida Ø 42

103	D	Confezione Package	Codice Code	Prezzo € Price
 Per Radiatori Alluminio Colore RAL 9010	1"	40 dx	103100001	0,826
	1"	40 sx	103100002	0,826
	1" x 1/8"	40 dx	103100181	0,941
	1" x 1/8"	40 sx	103100182	0,941
	1" x 1/4"	40 dx	103100141	0,941
	1" x 1/4"	40 sx	103100142	0,941
	1" x 3/8"	40 dx	103100381	0,941
	1" x 3/8"	40 sx	103100382	0,941
	1" x 1/2"	40 dx	103100121	0,941
	1" x 1/2"	40 sx	103100122	0,941
	1" x 3/4"	40 dx	103100341	1,669
	1" x 3/4"	40 sx	103100342	1,669

Serie 1" 1/4 verniciati con flangia Ø 56 - Range 1" 1/4, dressed with flange Ø 56
1" 1/4, Lackierte mit Flansch Ø 56 - Serie 1" 1/4, vernis bride Ø 56
Serie 1" 1/4, pintados con brida Ø 56

109/56	D	Confezione Package	Codice Code	Prezzo € Price
 Colore RAL 9010 Guarnizione in silicone montata sotto la flangia. Durezza 66 SH. Resistente a + 120°C.	1" 1/4	20 dx	109114001	2,369
	1" 1/4	20 sx	109114002	2,369
	1" 1/4 x 1/4"	20 dx	109114141	2,535
	1" 1/4 x 1/4"	20 sx	109114142	2,535
	1" 1/4 x 3/8"	20 dx	109114381	2,535
	1" 1/4 x 3/8"	20 sx	109114382	2,535
	1" 1/4 x 1/2"	20 dx	109114121	2,535
	1" 1/4 x 1/2"	20 sx	109114122	2,535
	1" 1/4 x 3/4"	20 dx	109114341	2,810
	1" 1/4 x 3/4"	20 sx	109114342	2,810
	1" 1/4 x 1"	20 dx	109114101	5,724
	1" 1/4 x 1"	20 sx	109114102	5,724

Serie 1" verniciati con flangia Ø 48 - Range 1", dressed with flange Ø 48
1", Lackierte mit Flansch Ø 48 - Serie 1", vernis bride Ø 48
Serie 1", pintados con brida Ø 48

102	D	Confezione Package	Codice Code	Prezzo € Price
 Per Radiatori Ghisa Colore RAL 9010	1"	40 dx	102100001	0,854
	1"	40 sx	102100002	0,854
	1" x 1/4"	40 dx	102100141	0,953
	1" x 1/4"	40 sx	102100142	0,953
	1" x 3/8"	40 dx	102100381	0,953
	1" x 3/8"	40 sx	102100382	0,953
	1" x 1/2"	40 dx	102100121	0,953
	1" x 1/2"	40 sx	102100122	0,953
	1" x 3/4"	40 dx	102100341	1,690
	1" x 3/4"	40 sx	102100342	1,690

Serie 1" 1/4 verniciati con flangia Ø 56 - Range 1" 1/4, dressed with flange Ø 56
1" 1/4, Lackierte mit Flansch Ø 56 - Serie 1" 1/4, vernis bride Ø 56
Serie 1" 1/4, pintados con brida Ø 56

107/56	D	Confezione Package	Codice Code	Prezzo € Price
 Colore RAL 9016 Guarnizione in silicone montata sotto la flangia. Durezza 66 SH. Resistente a + 120°C.	1" 1/4	20 dx	107114001	2,369
	1" 1/4	20 sx	107114002	2,369
	1" 1/4 x 1/4"	20 dx	107114141	2,535
	1" 1/4 x 1/4"	20 sx	107114142	2,535
	1" 1/4 x 3/8"	20 dx	107114381	2,535
	1" 1/4 x 3/8"	20 sx	107114382	2,535
	1" 1/4 x 1/2"	20 dx	107114121	2,535
	1" 1/4 x 1/2"	20 sx	107114122	2,535
	1" 1/4 x 3/4"	20 dx	107114341	2,810
	1" 1/4 x 3/4"	20 sx	107114342	2,810

NEW

Serie 1" verniciati con flangia Ø 42 - Range 1", dressed with flange Ø 42
1", Lackierte mit Flansch Ø 42 - Serie 1", vernis bride Ø 42
Serie 1", pintados con brida Ø 42

109/42	D	Confezione Package	Codice Code	Prezzo € Price
 Per Radiatori Alluminio Colore RAL 9010 Guarnizione in silicone montata sotto la flangia. Durezza 66 SH. Resistente a + 120°C.	1"	40 dx	109100001	1,014
	1"	40 sx	109100002	1,014
	1" x 1/8"	40 dx	109100181	1,096
	1" x 1/8"	40 sx	109100182	1,096
	1" x 1/4"	40 dx	109100141	1,096
	1" x 1/4"	40 sx	109100142	1,096
	1" x 3/8"	40 dx	109100381	1,096
	1" x 3/8"	40 sx	109100382	1,096
	1" x 1/2"	40 dx	109100121	1,096
	1" x 1/2"	40 sx	109100122	1,096
	1" x 3/4"	40 dx	109100341	1,724
	1" x 3/4"	40 sx	109100342	1,724

Tappi in ottone cromato

Serie 1/2" cromato con flangia Ø 28 filetto con tenuta OR
1/2" with flange Ø 28, thread with OR-seal
1/2" mit Flansch Ø 28, Gewinde mit OR - Dichtung
1/2" - Bride Ø 28 - filetage a etancheite par joint OR
1/2" Con brida Ø 28 rosca con junta torica

104/28	D	Confezione Package	Codice Code	Prezzo € Price
	1/2"	200 dx	104102001	0,994
	1/2" x 1/8"	200 dx	104102181	0,994
	1/2" x 1/4"	200 dx	104102141	0,994
	1/2" x 3/8"	200 dx	104102381	0,994

Serie 3/4" con flangia Ø 34 filetto con tenuta OR
3/4" with flange Ø 34, thread with OR-seal
3/4" mit Flansch Ø 34, Gewinde mit OR - Dichtung
3/4" - Bride Ø 34 - filetage a etancheite par joint OR
3/4" Con brida Ø 34 rosca con junta torica

104/34	D	Confezione Package	Codice Code	Prezzo € Price
	3/4"	150 dx	104304001	1,324
	3/4" x 1/8"	150 dx	104304181	1,324
	3/4" x 1/4"	150 dx	104304141	1,324
	3/4" x 3/8"	150 dx	104304381	1,324
	3/4" x 1/2"	150 dx	104304121	1,324

Tappo ottone cromato cappuccio bianco
Chromium-plate brass plug with white cap

104/B	D	Confezione Package	Codice Code	Prezzo € Price
	3/8"	100	104308000	0,719
	1/2"	100	104102000	0,719

Filetto con tenuta OR

Nippoli in acciaio per radiatori - Carbon steel nipples for radiators

958	D	Confezione Package	Codice Code	Prezzo € Price
	1"	250	958100000	0,649
	1"1/4	150	958114000	0,725

Chiave in nylon per tappi e riduzioni verniciate
Nylon key for plugs and reductions

100	D	Confezione Package	Codice Code	Prezzo € Price
	1/2" - 1" - 1" 1/4	50	101000001	8,023

Guarnizioni in cartoncino - Thin card - Steifpapier - Carton - Cartulina

950/C	D	Confezione Package	Codice Code	Prezzo € Price
	1" - 42	200	950111002	0,038
	1" - 48	200	950100002	0,038
	1"1/4 - 56	200	950114002	0,038

Guarnizione senza amianto - Asbestos free gasket
Asbestfrei - Sans amiante - Sin amianto

950/A	D	S mm	Confezione Package	Codice Code	Prezzo € Price
	1/2"-28	2	100	950102001	0,138
	3/4"-34	2	100	950304001	0,174
	1"-42	1	100	950111003	0,150
	1"-42	2	100	950111001	0,174
	1"-48	2	100	950100001	0,200
	1"1/4-56	1	100	950114003	0,264
	1"1/4-56	2	100	950114001	0,300

Guarnizioni in silicone - Silicone gaskets - Silikon - Silicone - Silicón

960	D	Confezione Package	Codice Code	Prezzo € Price
	1"	100	960100000	0,163
	1"1/4	100	960114000	0,238

Utilizzare esclusivamente per Tappi e Riduzioni con canalino

Guarnizioni per raccordi sanitari esenti amianto - Gaskets without asbestos

951	D	Confezione Package	Codice Code	Prezzo € Price
	3/8"	1000	951308000	0,025
	1/2"	1000	951102000	0,038
	3/4"	1000	951304000	0,038
	1"	1000	951100000	0,049
	1"1/4	100	951114000	0,076
	1"1/2	100	951112000	0,113
	2"	100	951200000	0,250

Spessore 2 mm
Wall thickness 2 mm
Wandstärke 2 mm
Epaisseur 2 mm
Espesor 2 mm

Guarnizioni in gomma per raccordi sanitari - Rubber gasket

952	D	Confezione Package	Codice Code	Prezzo € Price
	3/8"	100	952308000	0,038
	1/2"	100	952102000	0,038
	3/4"	100	952304000	0,038
	1"	100	952100000	0,064
	1"1/4	100	952114000	0,088
	1"1/2	100	952112000	0,125
	2"	100	952200000	0,275

Spessore 2 mm
Wall thickness 2 mm
Wandstärke 2 mm
Epaisseur 2 mm
Espesor 2 mm

Mensole piatte

Mensole piatte zincate per radiatori (Sp. 15/10) - Falt wall bracket (Thk. 15/10)

851	D	Confezione Package	Codice Code	Prezzo € Price
	19 cm	100	851000190	0,626
	23 cm	100	851000230	0,662
	26 cm	100	851000260	0,750
	29 cm	100	851000290	0,972

Mensole doppie zincate per radiatori (Sp. 15/10) - Double wall bracket (Thk. 15/10)

901	D	Confezione Package	Codice Code	Prezzo € Price
	18 cm	80	901000180	0,765
	23 cm	50	901000230	0,841
	26 cm	50	901000260	0,917
	29 cm	100	901000290	1,129

Mensole piatte per radiatori alluminio (Sp. 15/10) - Falt wall bracket (Thk. 15/10)

1000	D	Confezione Package	Codice Code	Prezzo € Price
	17 cm	200	999000000	0,484
	20 cm	200	999000200	0,538

Mensole zincate reversibili destra e sinistra - Galvanized square brackets, right & left reversible - Links-u. Rechtsumkehr Winkellosen Solen - Support equerre reversible droite et gauche - Soportes en escuadra reversibles a derecha e izquierda

855	D	Confezione** Package	Codice Code	Prezzo Coppia € Price
		30	855000000	2,310
	Elementi componenti il kit: - n.2 mensole; - n.4 viti ø 8x60; - n.4 tasselli ø 10x60.			

Mensole zincate e verniciate reversibili destra e sinistra - Galvanized & painted square brackets, right & left reversible - Links-u. Rechtsumkehr Winkellosen Solen Support equerre reversible droite et gauche - Soportes en escuadra reversibles a derecha e izquierda

855V	D	Confezione** Package	Codice Code	Prezzo Coppia € Price
		30	855000000V	3,098
	Elementi componenti il kit: - n.2 mensole; - n.4 viti ø 8x60; - n.4 tasselli ø 10x60.			

NEW

Mensole zincate regolabili per radiatori alluminio
Adjustable brackets for aluminium radiators

943	D	Confezione** Package	Codice Code	Prezzo Coppia € Price
		1	943000000	3,091

Mensole zincate con tassello ad espansione

Radiatori 2-4 colonne - 2-4 Columns radiators
2-4 Saulenradiatoren - Radiateurs 2-4 colonnes - Radiadores 2-4 columnas

942 M 2-4	Mensola Steel bracket	Tassello Nylon dowel	Confezione** Package	Codice Code	Prezzo Coppia € Price
	ø 10,7x205	ø 15*x86	25	942240000	2,867

Radiatori 4-6 colonne - 4-6 Columns radiators
4-6 Saulenradiatoren - Radiateurs 4-6 colonnes - Radiadores 4-6 columnas

942 M 4-6	Mensola Steel bracket	Tassello Nylon dowel	Confezione** Package	Codice Code	Prezzo Coppia € Price
	ø 10,7x245	ø 15*x86	25	942460000	2,978

Radiatori alluminio - Aluminium radiators - Alu-radiatoren
Radiateurs en aluminium - Radiadores de aluminio

942 MA	Mensola Steel bracket	Tassello Nylon dowel	Confezione** Package	Codice Code	Prezzo Coppia € Price
	ø 7x170	ø 10*x83	50	942195004	1,686
	ø 8,8x170	ø 12*x83	50	942195000	1,686

Mensole schiacciata - Aluminium radiators - Alu-radiatoren
Radiateurs en aluminium - Radiadores de aluminio

942 MA/S	Mensola Steel bracket	Tassello Nylon dowel	Confezione** Package	Codice Code	Prezzo Coppia € Price
	ø 7x170	ø 10*x83	50	942195005	1,911
	ø 8,8x170	ø 12*x83	50	942195001	1,911
	ø 8,8x245	ø 12*x83	40	942245001	2,753

Mensole zincata per radiatori tubolari - Galvanized steel bracket for tubular radiators

942 M	Mensola Steel bracket	Tassello Nylon dowel	Confezione** Package	Codice Code	Prezzo Coppia € Price
	ø 8,8x175	ø 12*x83	40	942175880	2,743
	ø 8,8x205	ø 12*x83	40	942205880	2,980
	ø 8,8x245	ø 12*x83	40	942245880	3,217

Radiatori lamellari e caldaie murali - Steel plates and water heaters
Lamellenradiatoren und Wandkessel - Radiateurs lamellaires et chaudières murales
Placas radiantes y calderas murales

942 MU	Mensola Steel bracket	Tassello Nylon dowel	Confezione** Package	Codice Code	Prezzo Coppia € Price
	ø 7x130	ø 10*x83	50	942130000	1,823

* FORATURA

** COPPIE

Mensole verniciate con tassello ad espansione
**Radiatori 2-4 colonne - 2-4 Columns radiators
4-6 Saulenradiatoren - Radiateurs 2-4 colonnes - Radiadores 2-4 columnas**

942 M2-4	Mensola Steel bracket	Tassello Nylon dowel	Confezione** Package	Codice Code	Prezzo Coppia € Price
	ø 10,7x205	ø 15*x86	25	942240001	3,635

**Radiatori 4-6 colonne - 4-6 Columns radiators
4-6 Saulenradiatoren - Radiateurs 4-6 colonnes - Radiadores 4-6 columnas**

942 M4-6	Mensola Steel bracket	Tassello Nylon dowel	Confezione** Package	Codice Code	Prezzo Coppia € Price
	ø 10,7x245	ø 15*x86	25	942460001	3,696

**Radiatori alluminio - Aluminium radiators - Alu-radiatoren
Radiateurs en aluminium - Radiadores de aluminio**

942 MA	Mensola Steel bracket	Tassello Nylon dowel	Confezione** Package	Codice Code	Prezzo Coppia € Price
	ø 7x170	ø 10*x83	50	942195006	2,022
	ø 8,8x170	ø 12*x83	50	942195002	2,022

**Mensola schiacciata - Aluminium radiators - Alu-radiatoren
Radiateurs en aluminium - Radiadores de aluminio**

942 MA/S	Mensola Steel bracket	Tassello Nylon dowel	Confezione** Package	Codice Code	Prezzo Coppia € Price
	ø 7x170	ø 10*x83	50	942195007	2,247
	ø 8,8x170	ø 12*x83	50	942195003	2,247

**Mensola verniciata per radiatori tubolari
Painted steel bracket for tubular radiators**

942 M	Mensola Steel bracket	Tassello Nylon dowel	Confezione** Package	Codice Code	Prezzo Coppia € Price
	ø 8,8x175	ø 12*x83	40	942175881	3,576
	ø 8,8x205	ø 12*x83	40	942205881	3,635
	ø 8,8x245	ø 12*x83	40	942245881	3,933

Rosette e tappi collaudo impianti
Rosetta apribile in PVC color bianco - Front cover in white PVC

225	D	Confezione Package	Codice Code	Prezzo € Price
	10	400	225000010	0,164
	12	400	225000012	0,164
	14	400	225000014	0,164
	15	400	225000015	0,164
	16	400	225000016	0,164
	18 - 3/8"	400	225000018	0,189
	22 - 1/2"	400	225000022	0,189
	26 - 3/4"	400	225000026	0,219

Rosetta apribile in PVC bianco universale per tubi rame - Front cover in white PVC

225 bis	D	Confezione Package	Codice Code	Prezzo € Price
	da 10 a 22	400	225000100	0,142

**Rosetta apribile doppia in PVC bianco universale per tubi rame
Double front cover in white PVC**

225 ter	D	Confezione Package	Codice Code	Prezzo € Price
	da 10 a 22	200	225000200	0,759

**Tappi rossi, blu, bianchi per prova impianto ø 1/2"
Red, blu and white plugs for hydraulic test drain**

226	D	Confezione Package	Codice Code	Prezzo € Price
	ø 1/2" Rosso	100	22600000R	0,419
	ø 1/2" Blu	100	22600000B	0,419
	ø 1/2" Bianco	100	226000001	0,419

Importante: avvitare e mano
*** FORATURA**
**** COPPIE**

Apparecchiature per impianti idrotermici

Separatore d'aria - Air separator - Luftabscheider
 Separateur d'air - Separador de aire

500	D	Confezione Package	Codice Code	Prezzo € Price
	1"	1	500100000	69,675
	1"1/4	1	500114000	71,656
	1"1/2	1	500112000	75,315
	2"	1	500200000	102,912
	2"1/2	1	500212000	230,824
	3"	1	500300000	271,379

Valvola automatica sfogo aria Besser - Automatic float airvent Besser
 Schnellentluffer Besser - Purgeur d'air automatique Besser
 Purgador automat de aire Besser

970	D	Confezione Package	Codice Code	Prezzo € Price
	3/8"	10	970308000	9,975
	1/2"	10	970102000	9,975

Valvola automatica sfogo aria baby Besser - Automatic float airvent baby Besser
 Schnellentluffer Babybesser - Purgeur d'air automatique baby Besser
 Purgador automat de aire baby Besser

972	D	Confezione Package	Codice Code	Prezzo € Price
	3/8"	10	972308000	6,563
	1/2"	10	972102000	6,563

Valvola d'intercettazione per art. 970 - 972 Ø 3/8"
 Shut-off valve - Absperventil - Vanne d'isol - Valvula de retenc

971	D	Confezione Package	Codice Code	Prezzo € Price
	F 3/8"-M 3/8"	250	971308308	2,822
	F 3/8"-M 1/2"	200	971308102	2,822

Valvola manuale scarico radiatori - Manual valve for radiators

975	D	Confezione Package	Codice Code	Prezzo € Price
	1/8" Nichelato	500	975108000	1,149
	1/4" Nichelato	500	975104000	1,149
	3/8" Nichelato	500	975308000	1,313

Valvola manuale scarico radiatori con anello in PTFE
 Manual drain valve for radiators with PTFE ring

975/G	D	Confezione Package	Codice Code	Prezzo € Price
	1/4" Nichelato	500	97510400G	1,555
	3/8" Nichelato	500	97530800G	2,330
	1/2" Nichelato	250	97510200G	2,520

NEW

Tappo in ottone con valvola scarico aria - Radiators brass plug with air vents
 Messingstopfen mit Handventil Entlüftung - Clapet en laiton avec purgeur d'air
 Tapon de laiton con purgador de aire

979	D	Confezione Package	Codice Code	Prezzo € Price
	3/8" Nichelato	150	979308002	1,800
	1/2" Nichelato	150	979102002	2,199
	3/4" Nichelato	150	979304002	3,650

NEW

Chiavetta in nylon per art. 979 - Nylon key for 979

979/C	D	Confezione Package	Codice Code	Prezzo € Price
		100	979000000	0,287

